

# JOYSTICK ENCODER

# CJ25

## FEATURES

- Multi-function device ... Joystick, optical encoder, and push switch functions in one package.
- Suitable size for panels. Smooth operational feel.
- Long life ... Joystick 500K cycles, encoder & switch 1M cycles
- RoHS compliant



## APPLICATIONS

Operation panels for;

- Medical device
- Broadcast equipment
- Surveillance camera etc.

## PART NUMBER DESIGNATION

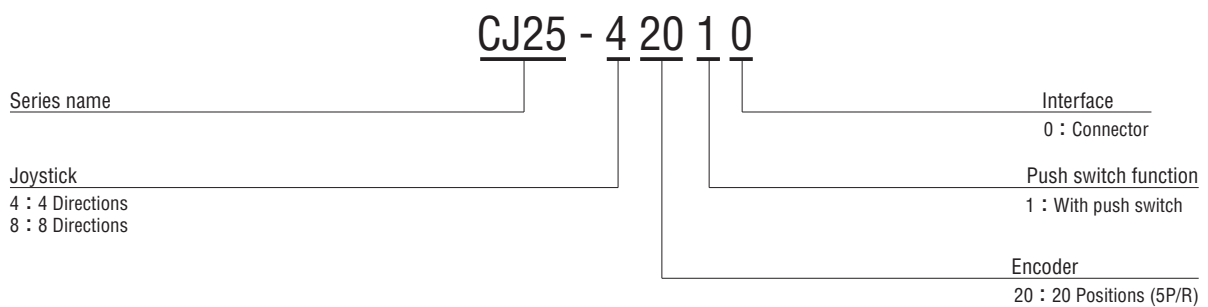

## LIST OF PART NUMBERS

Part number	Joystick	Encoder	Push switch function	Interface
<b>CJ25-42010</b>	4 directions	20 Positions(5P/R)	With push switch	Connector
<b>CJ25-82010</b>	8 directions			

# CJ25

## JOYSTICK ENCODER

### STANDARD SPECIFICATIONS

#### Electrical characteristics

##### Encoder

Input voltage	DC5 V $\pm$ 5 %
Input current	20mA maximum at 5V
Output wave form	Incremental signal (Square wave)
Pulses Per Rotation	5P/R
Maximum frequencies response	10Hz
Output	Open collector, Pull-up resistor 2.2K $\Omega$
Output Code	2-Bit, Channel A/B, Phase difference 90°
Output Signal	High : 3.8V minimum Low : 0.4V maximum
Output Sink Current	6mA minimum

##### Joystick

Input current	5mA maximum at 5V
Output Code	2-Bit (X,Y)
Output Signal	Neutral : 2.5 $\pm$ 0.5V High : 4.5V minimum Low : 0.5V maximum

##### Switch

Rating	DC5V, 10mA
Contact Resistance	10 $\Omega$ maximum
Contact Bouncing	Switching : 4ms make Non-switching : 10ms break

#### Mechanical characteristics

Mounting Torque	1.17N · m maximum (12kgf · cm maximum)
Actuator Strength	19.6N maximum (2kg maximum)
Max. Shaft Pull-out Strength	98N maximum (10kg maximum)
Max. Shaft Push-out Strength	98N maximum (10kg maximum)

##### Encoder

Click Torque	9.8 $\pm$ 4.9mN · m (100 $\pm$ 50gf · cm)
Clicks Per Rotation	20
Rotational Life	1 million cycles

##### Joystick

Angle of Throw	All directions 9 $\pm$ 2°
Operating Force	X,Y 1.47 $\pm$ 0.74N (150 $\pm$ 75gf)
Joystick Life	500,000 actuation each in directions (X, Y)

##### Switch

Operating Force	3.43 $\pm$ 1.47N (350 $\pm$ 150gf)
Stroke	0.5 $\pm$ 0.2mm
Switching Life	1 million cycles

#### Environmental characteristics

Operating Temp. Range	0°C ~ + 50°C
Storage Temp. Range	-20 ~ 80°C

### RELIABILITY TEST

Test item		Test conditions
Vibration	Power OFF	Amplitude : 1.52mm or 98.1m/s <sup>2</sup> (10G) whichever is smaller. 10 ~ 500Hz excursion 15 min/cycle, 8 cycles each for X, Z, directions.
Shock	Power OFF	3 times each in directions (X, Z) at 490m/s <sup>2</sup> (50G), 11ms.
High temperature exposure	Power OFF	80 °C 96 h
	Power ON	50 °C 96 h
Low temperature exposure	Power OFF	- 20 °C 96 h
	Power ON	0 °C 96 h
Humidity	Power OFF	40 °C Relative humidity 90 ~ 95 % 96 h (To be measured after wiping out moisture and leaving samples for 1 h at normal temperature and humidity after the test.)
Thermal shock	Power OFF	To be done 10 cycles with the following condition (To be measured after leaving samples for 1 h at normal temperature and humidity after the test.) 80 °C 0.5 h、- 20 °C 0.5 h

# CJ25 JOYSTICK ENCODER

## OUTLINE DIMENSIONS

### PIN ASSIGNMENT

Pin No.	Function
1	Joystick "X"
2	Joystick "Y"
3	Power "+5V"
4	Output "A"
5	Output "B"
6	Switch
7	Switch
8	GND

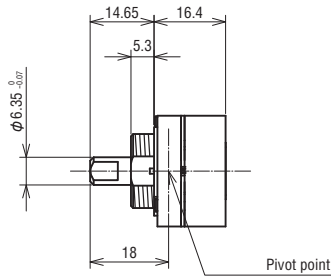

Unless otherwise specified, tolerance:  $\pm 0.4$  (Unit: mm)

### <Accessories>

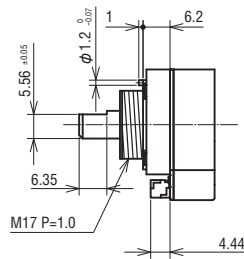
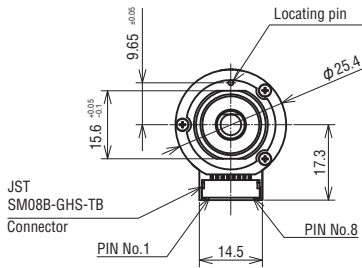
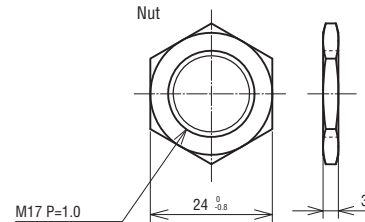

### <Panel cut-out dimensions>

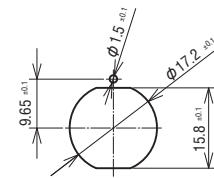

## OUTPUT

### JOYSTICK

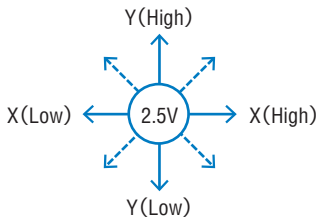

"Y (High)" defined by locating pin.

### ENCODER Output Waveform

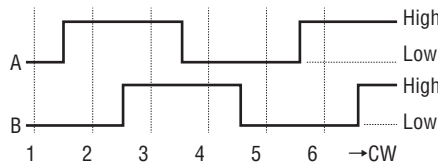

Position number: 1~6... (Clockwise rotation)

Position	Output	A	B
1			
2		●	
3		●	●
4			●

● = High  
blank = Low

※ Code repeats every 4 positions.

### SWITCH

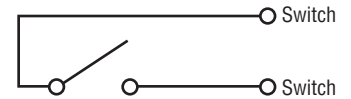

## OPTION

### (Wire harnesses)

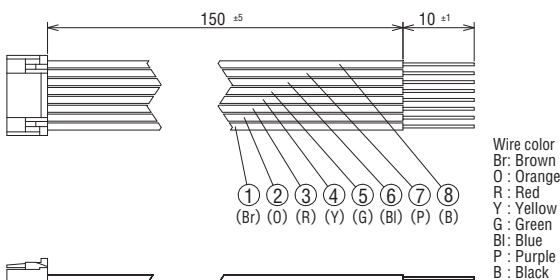

Optional wire harnesses are available upon request.

## OUTPUT CIRCUITRY AND RECEIVING CIRCUITRY

